

## ESPERIA\_89\_plus

ESCALA 1:1

1

- (I) Sezione verticale traverso inferiore
- (F) Section verticale traverse inferieure
- (E) Seccion vertical travesano inferior
- (UK) Vertical section lower ledger

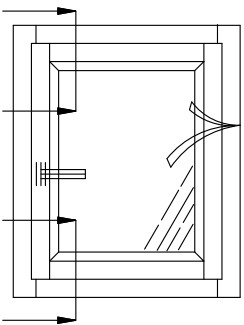
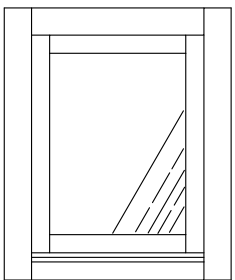
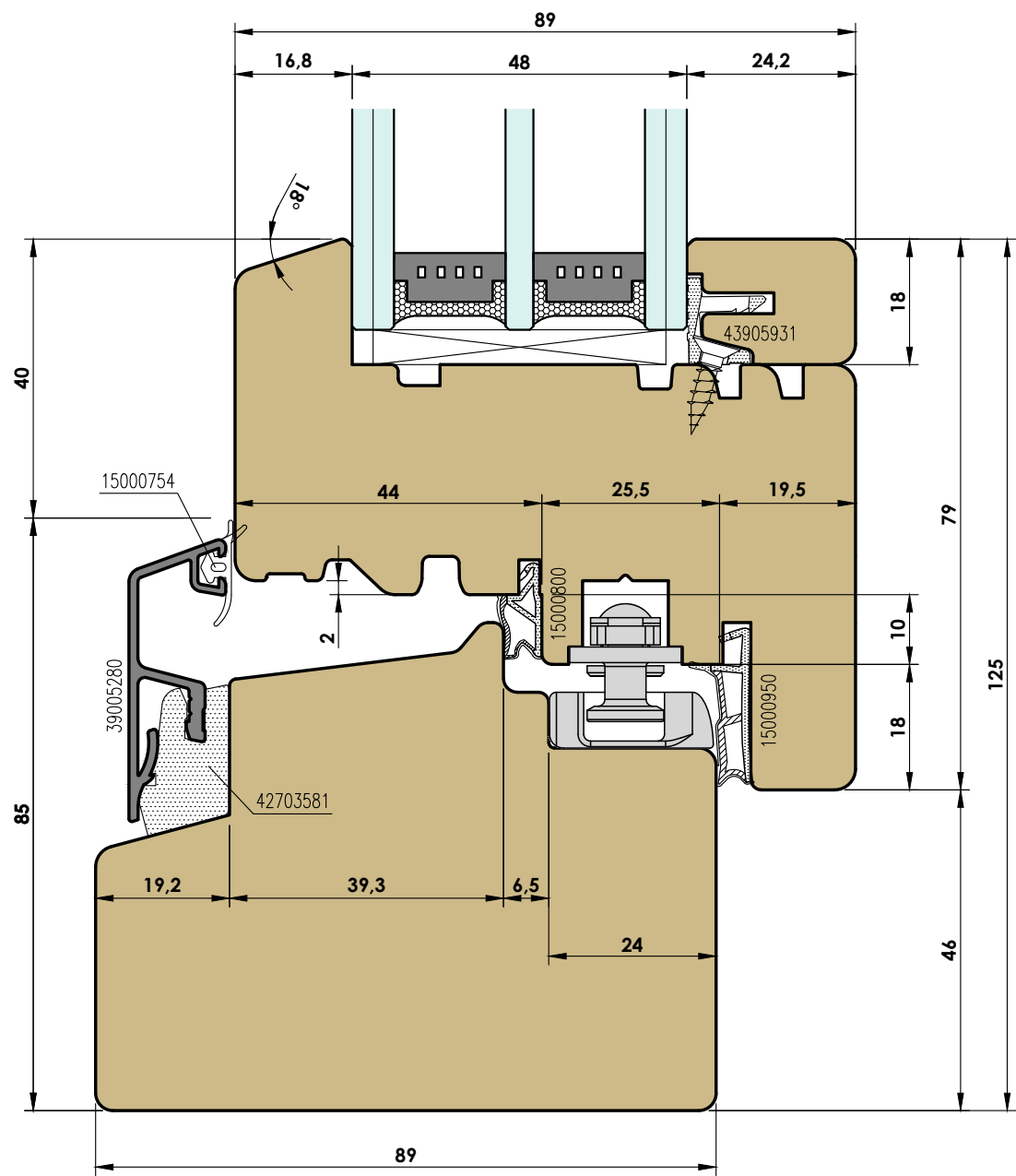
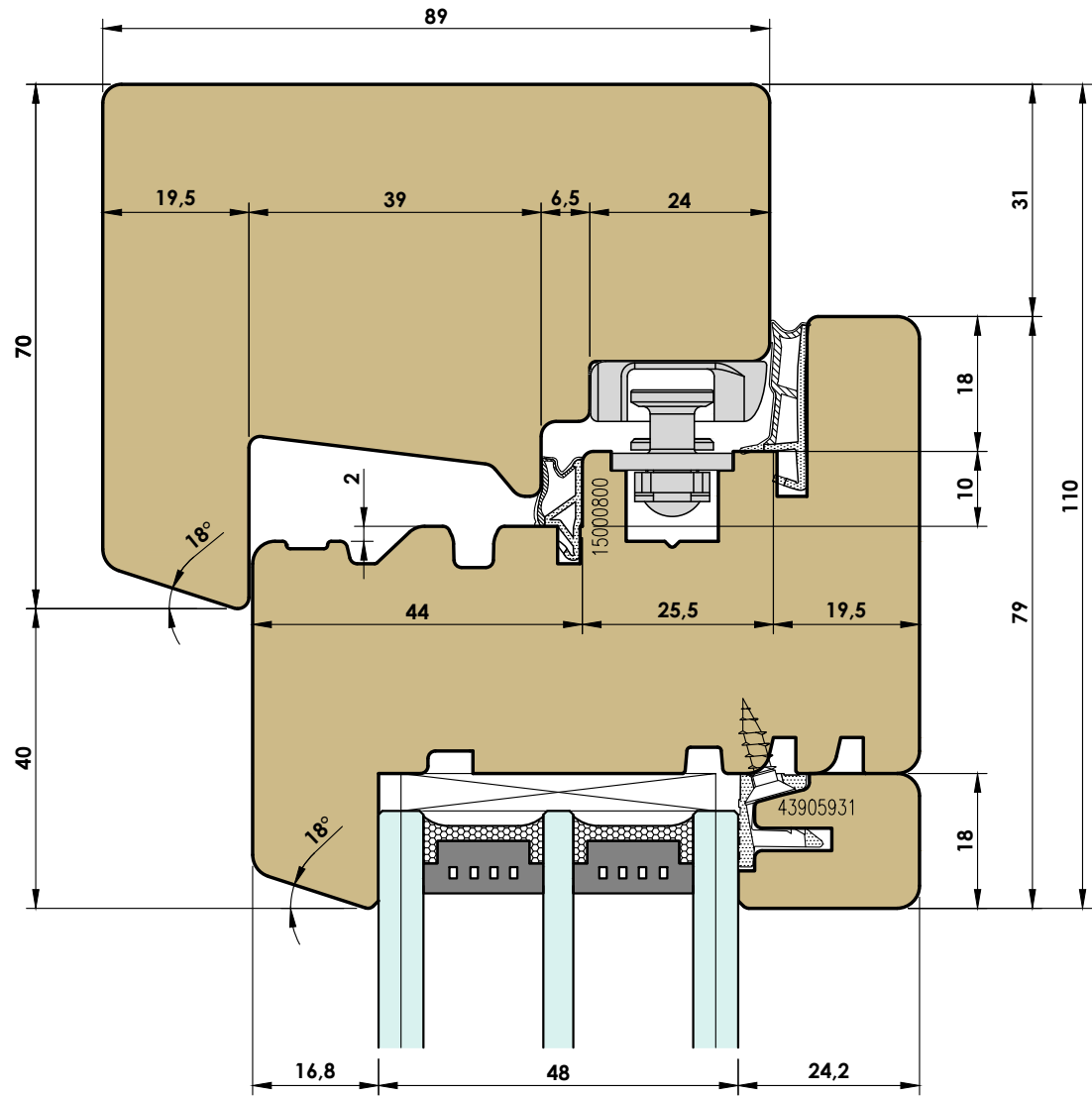

ESPERIA\_89\_plus

ESCALA 1:1

2

- (I) Sezione verticale traverso inferiore
- (F) Section verticale traverse inferieure
- (E) Seccion vertical travesano inferior
- (UK) Vertical section lower ledger

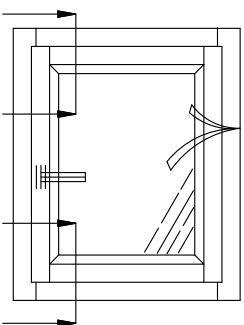
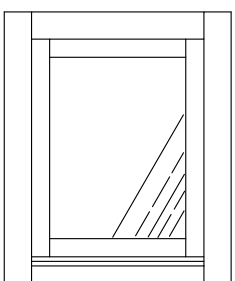
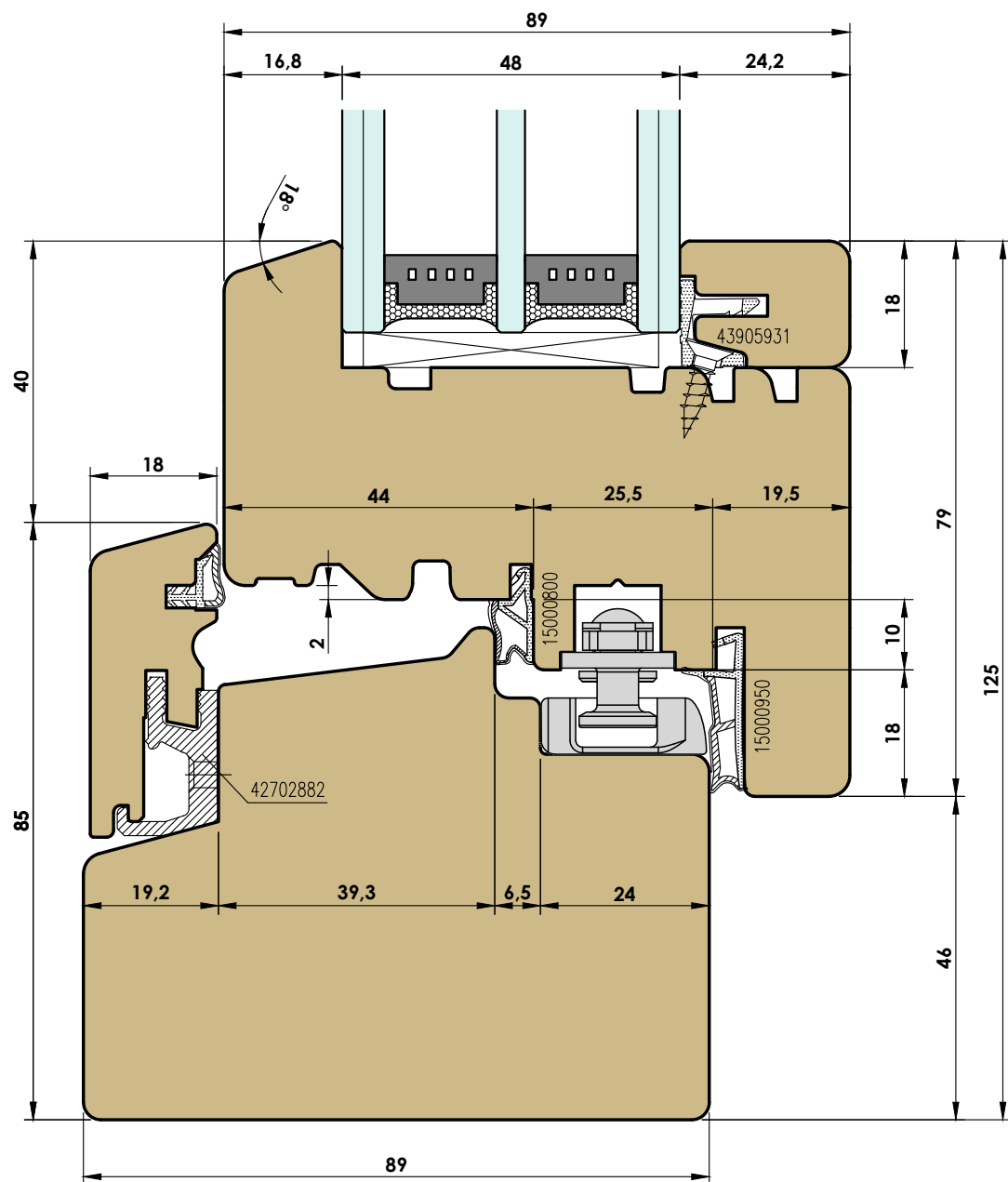
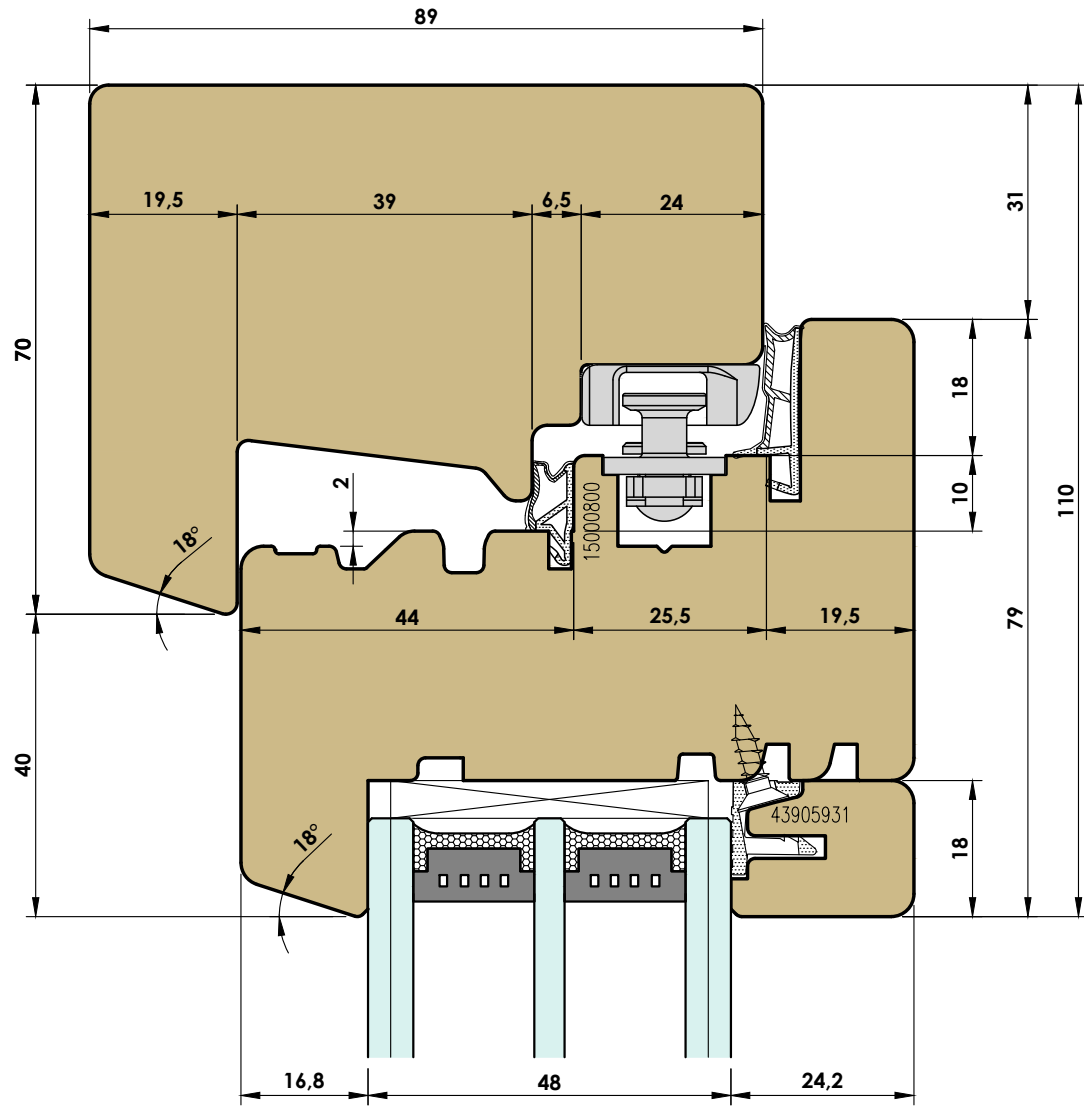

### ESPERIA\_89\_plus

ESCALA 1:1

3

- (I) Sezione verticale traverso inferiore
- (F) Section verticale traverse inferieure
- (E) Seccion vertical travesano inferior
- (UK) Vertical section lower ledger

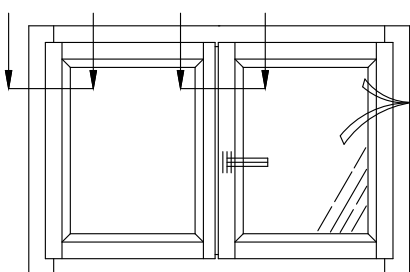
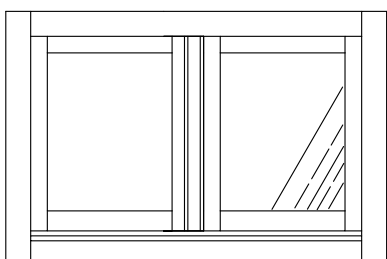
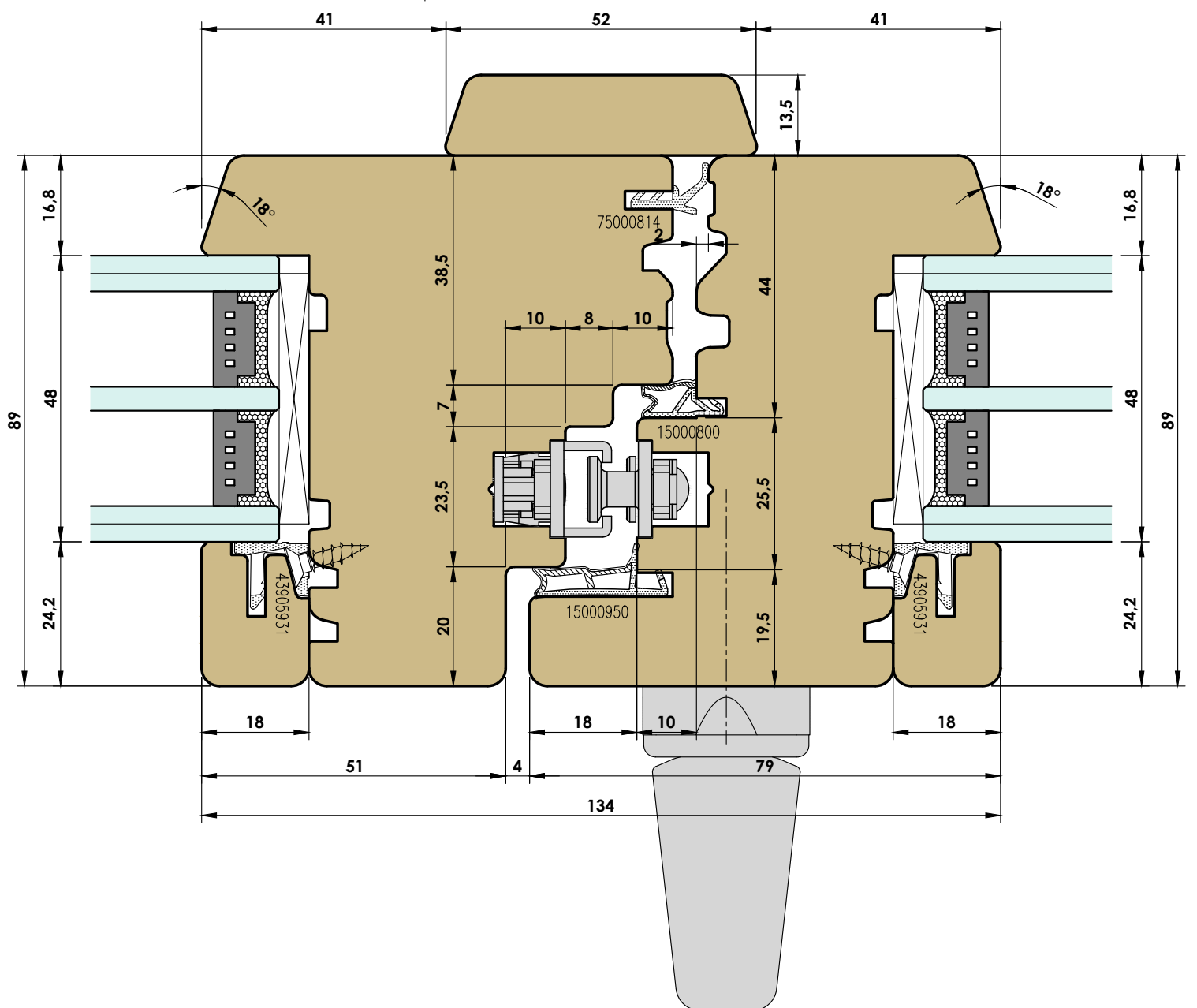
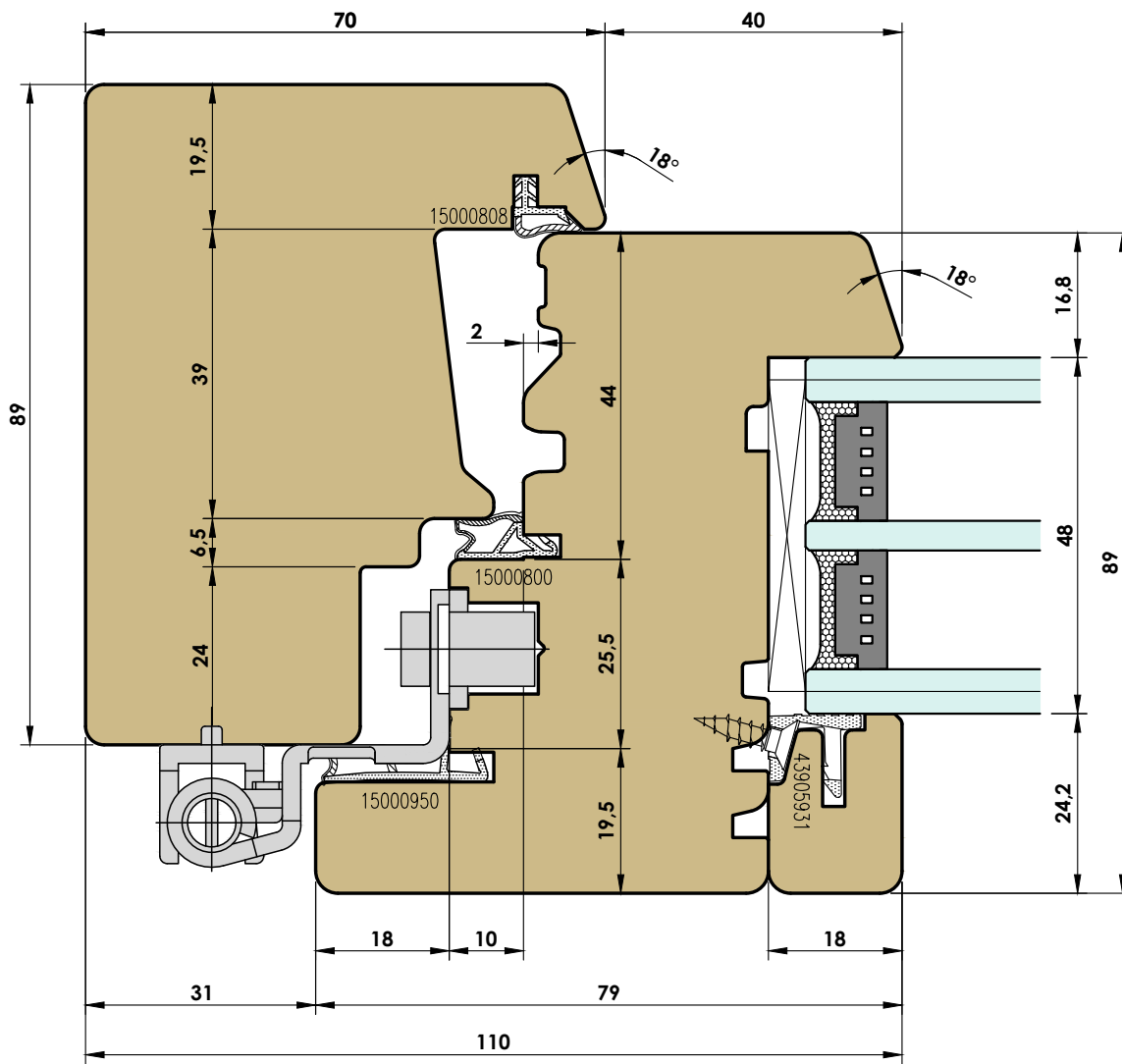

## ESPERIA\_89\_plus

ESCALA 1:1

4

- (I) Sezione orizzontale snodo centrale
- (F) Section horizontale montant centrale
- (E) Seccion horizontal cierre central
- (UK) Horizontal section of the middle clamp

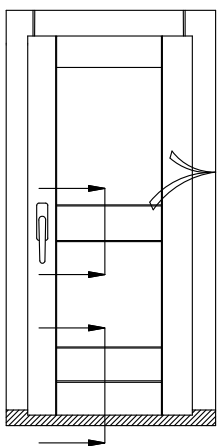
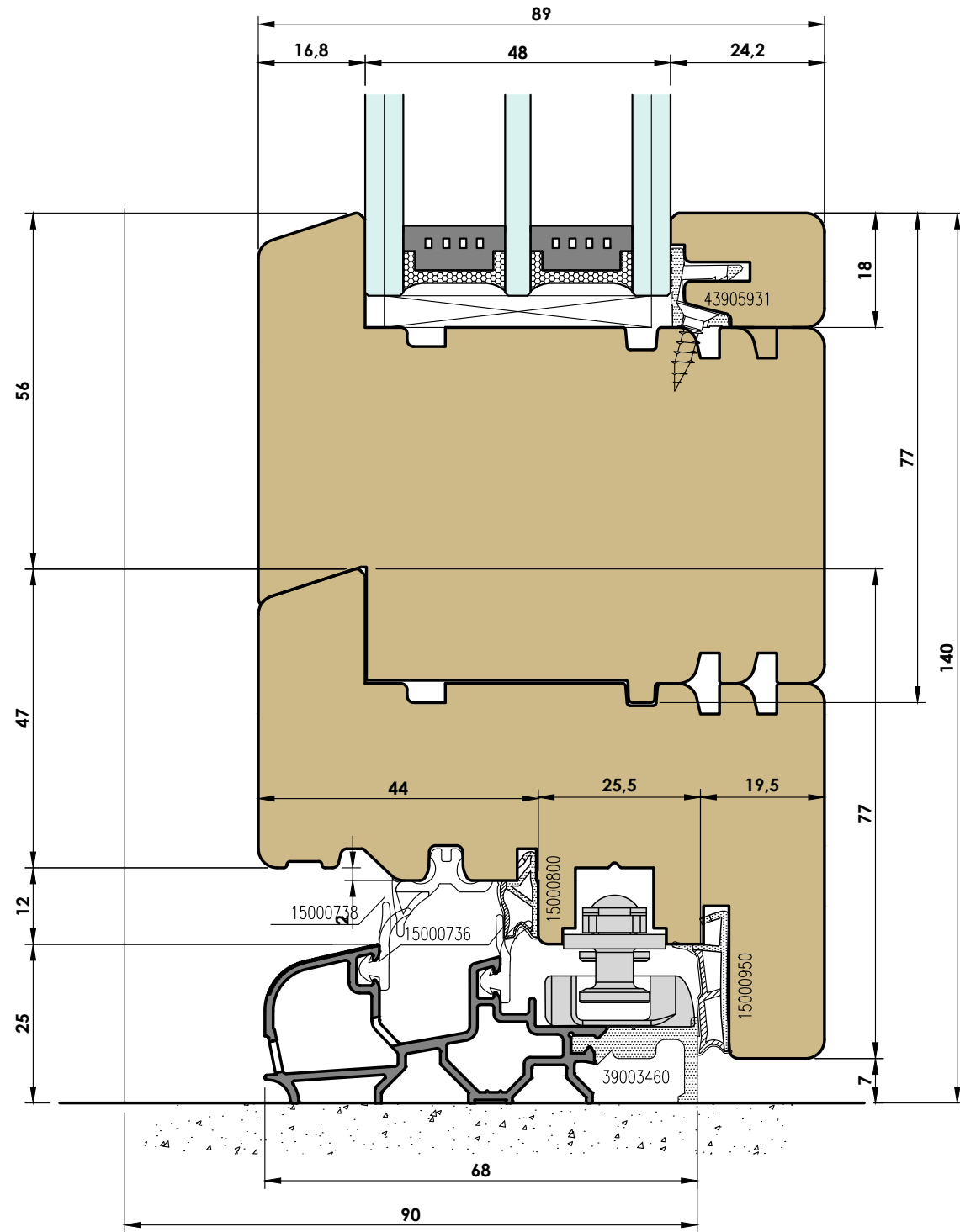
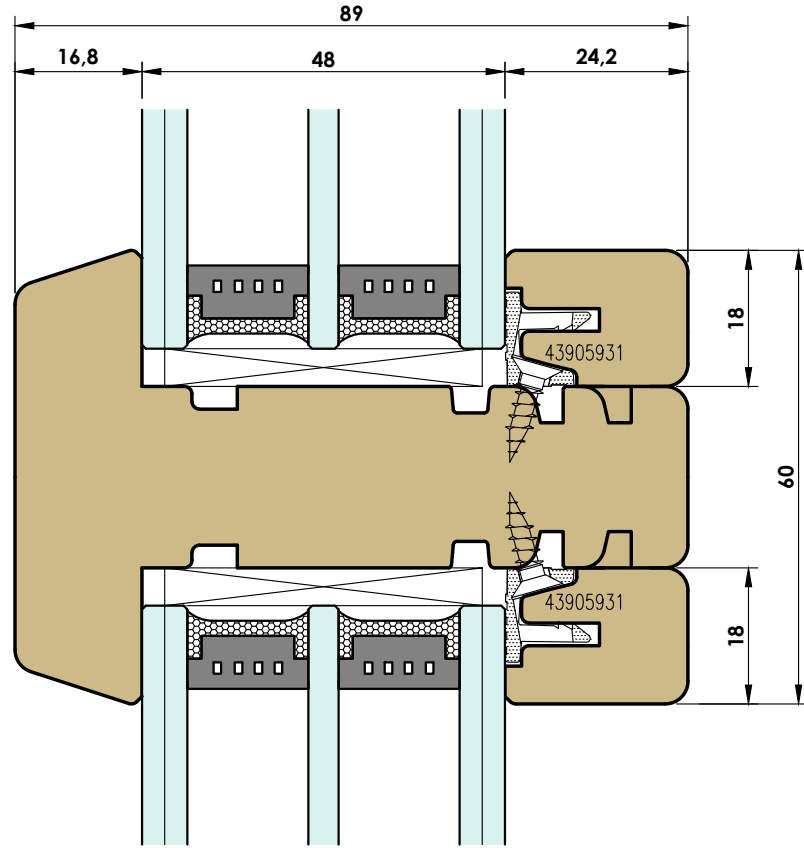

### ESPERIA\_89\_plus

ESCALA 1:1

5

- (I) Sezione verticale traverso inferiore
- (F) Section verticale traverse inferieure
- (E) Seccion vertical travesañño inferior
- (UK) Vertical section lower ledger

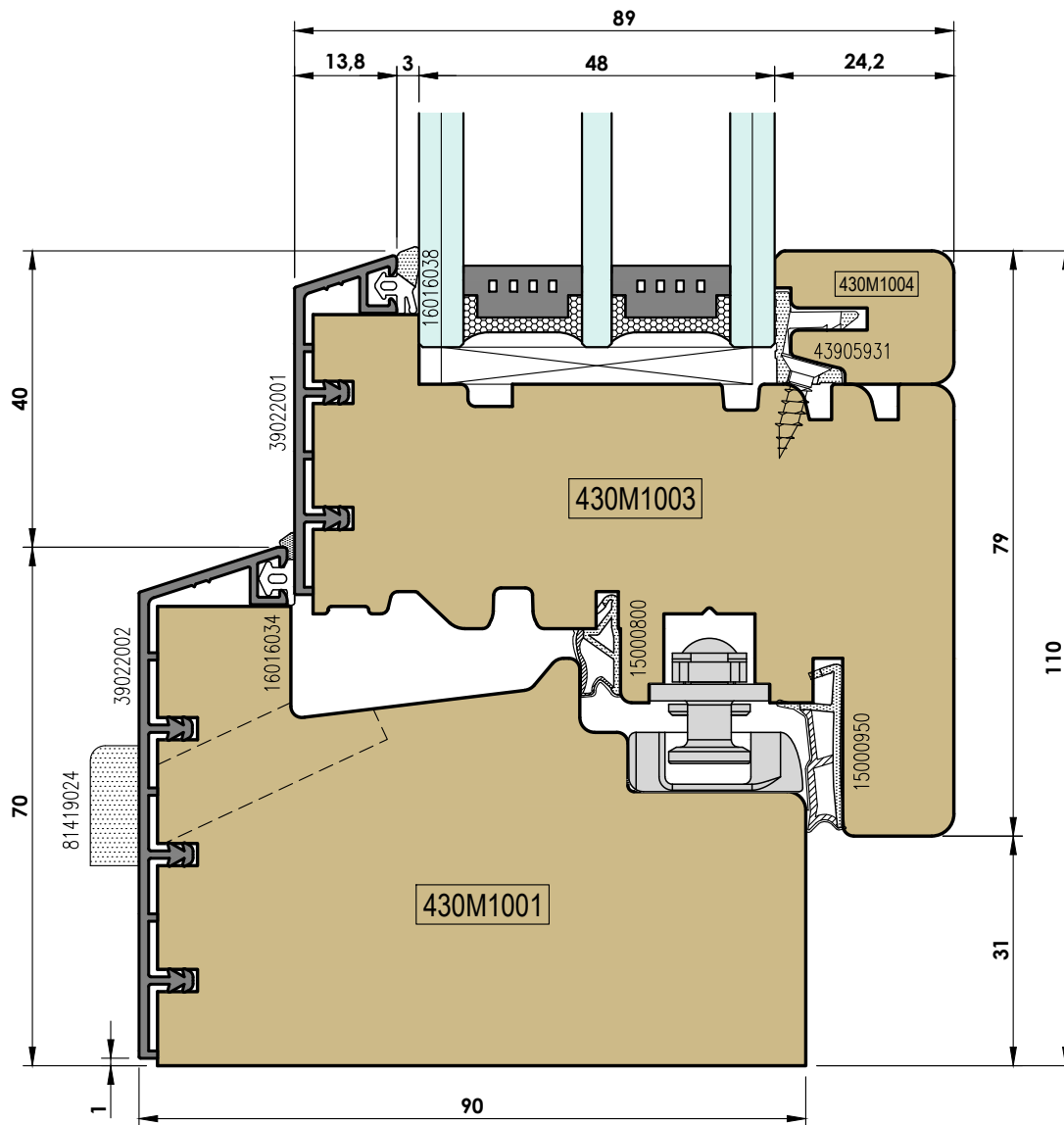
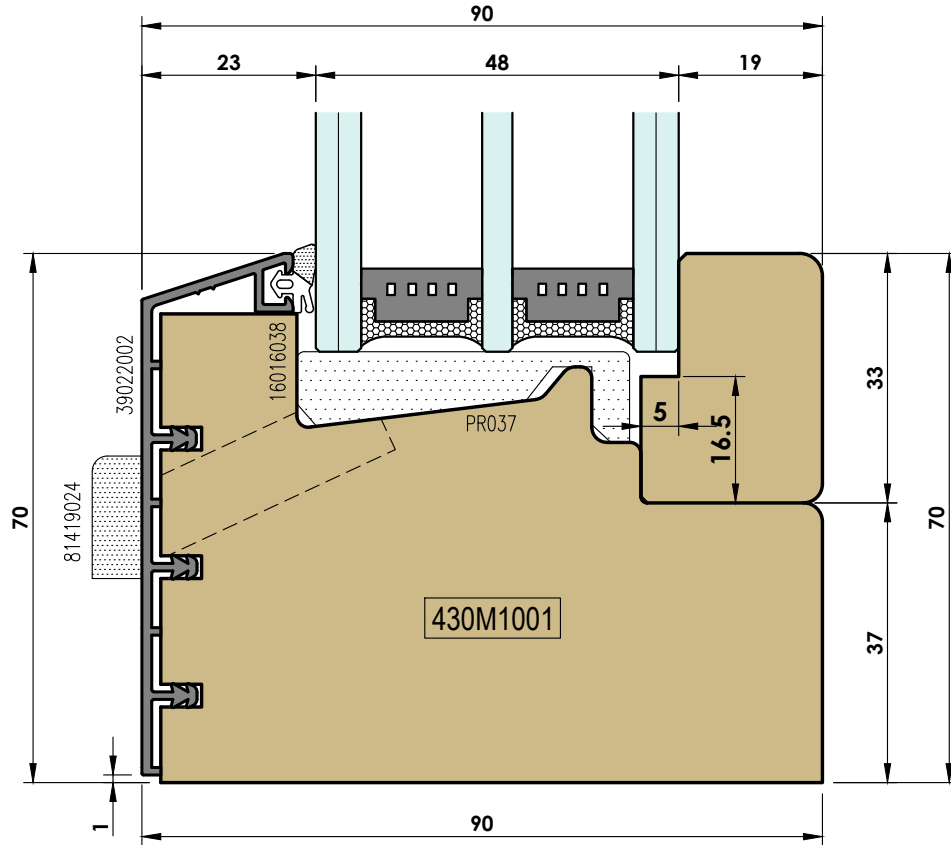

### HERMOD\_89

ESCALA 1:1

1

- Ⓛ Sezione verticale traverso inferiore
- Ⓧ Section verticale traverse inferieure
- Ⓝ Seccion vertical travesañõ inferior
- Ⓤ Vertical section lower ledger

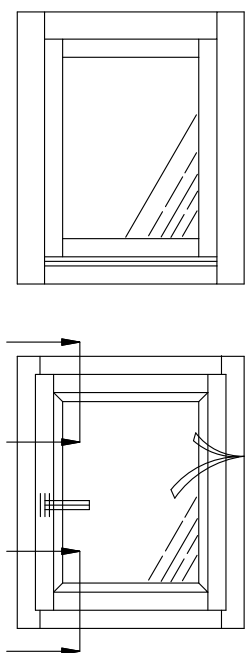

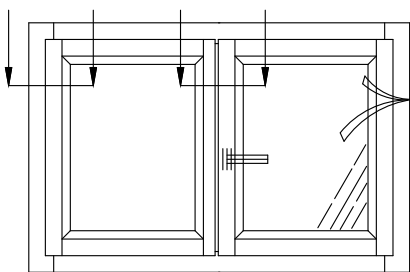
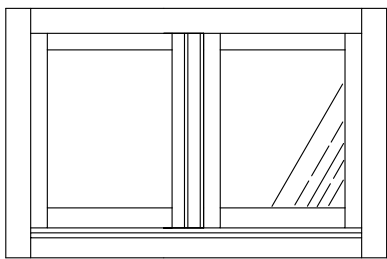
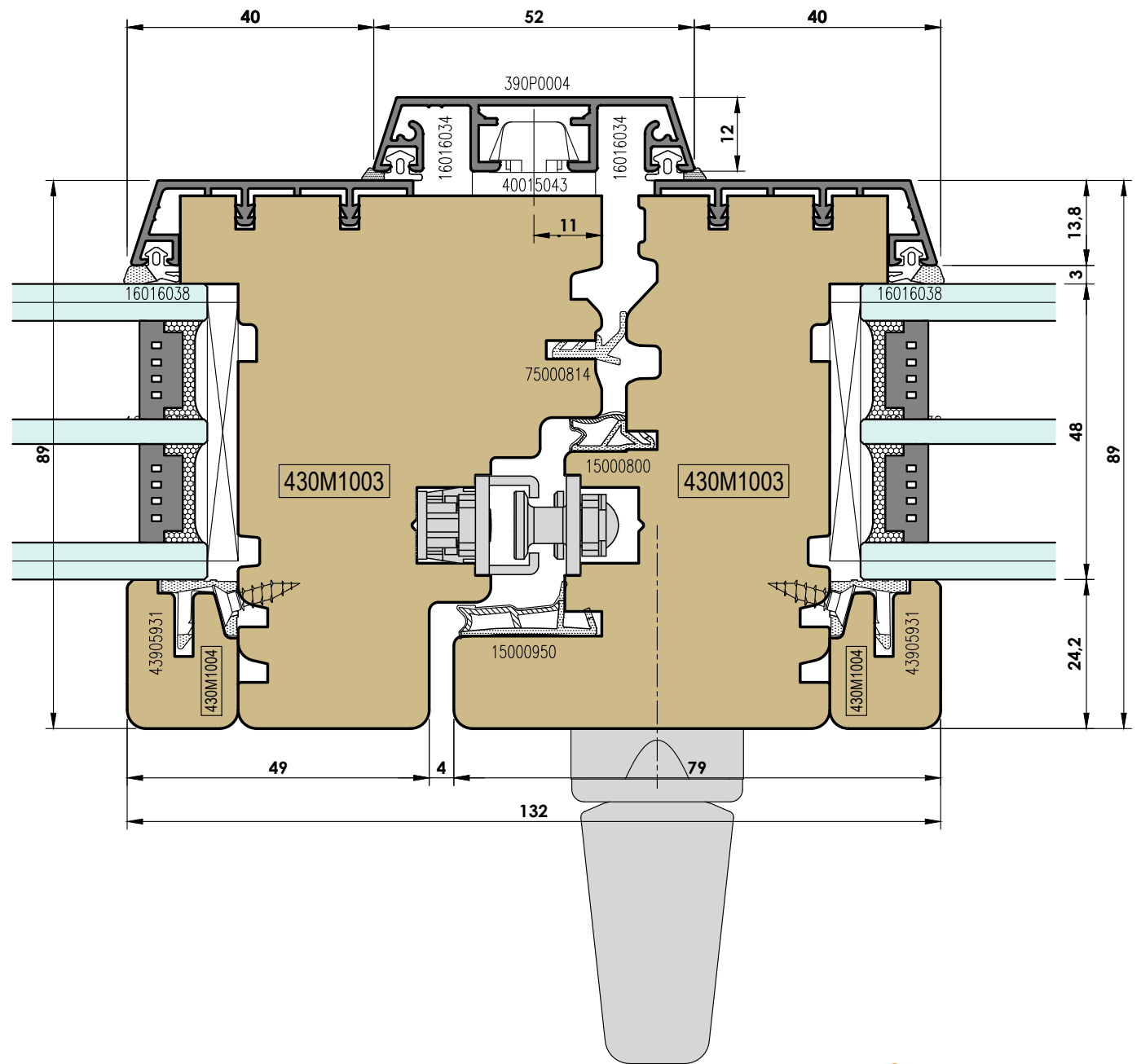
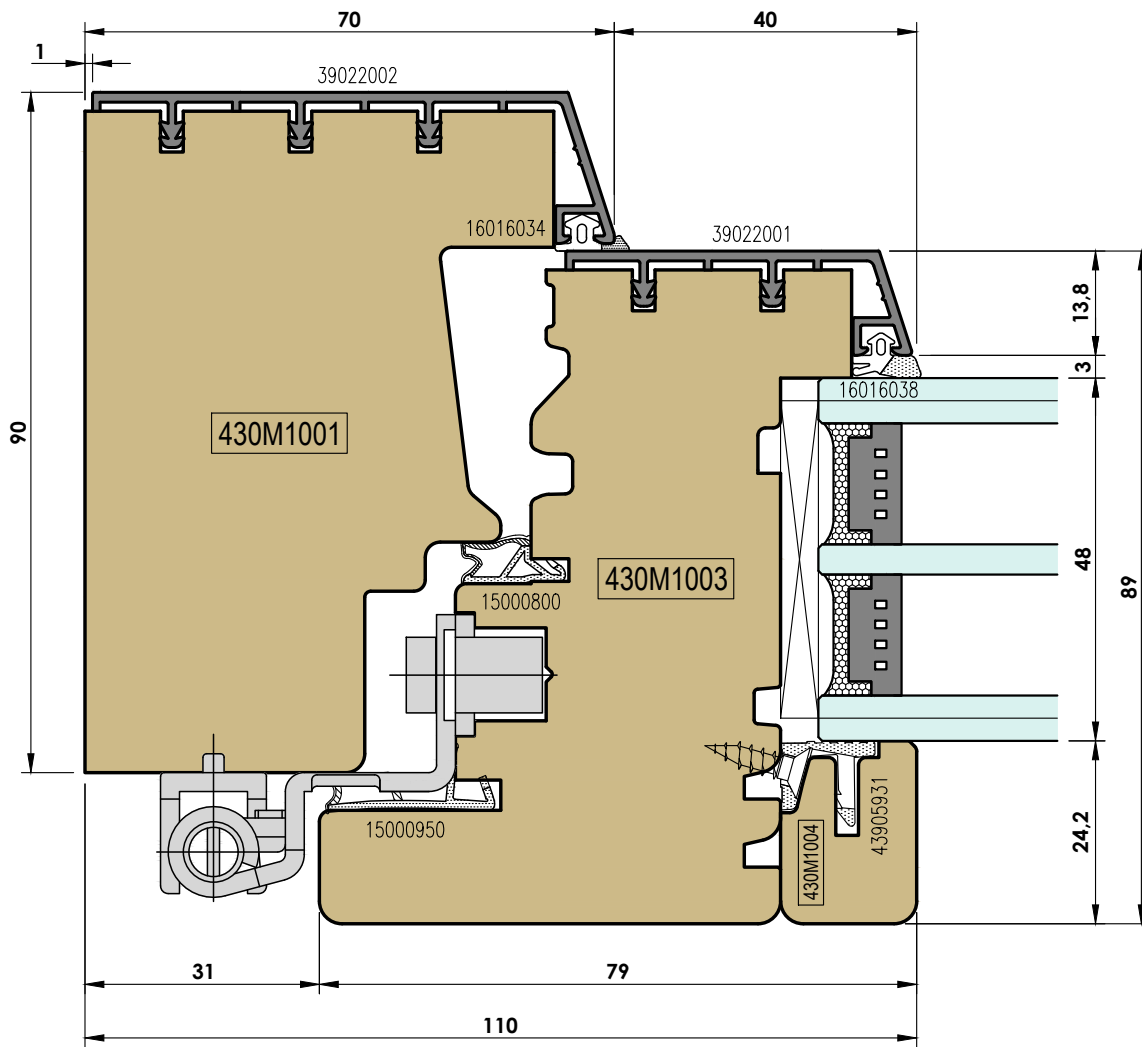

HERMOD\_89

ESCALA 1:1

- (I) Sezione orizzontale snodo centrale
- (F) Section horizontale montant centrale
- (E) Seccion horizontal cierre central
- (UK) Horizontal section of the middle clamp

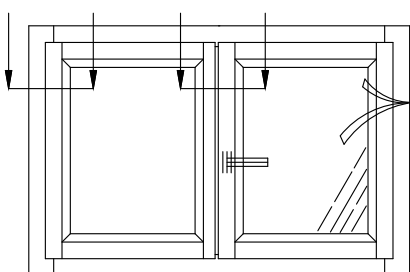
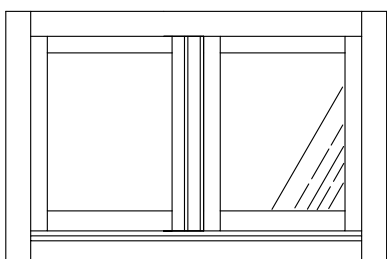
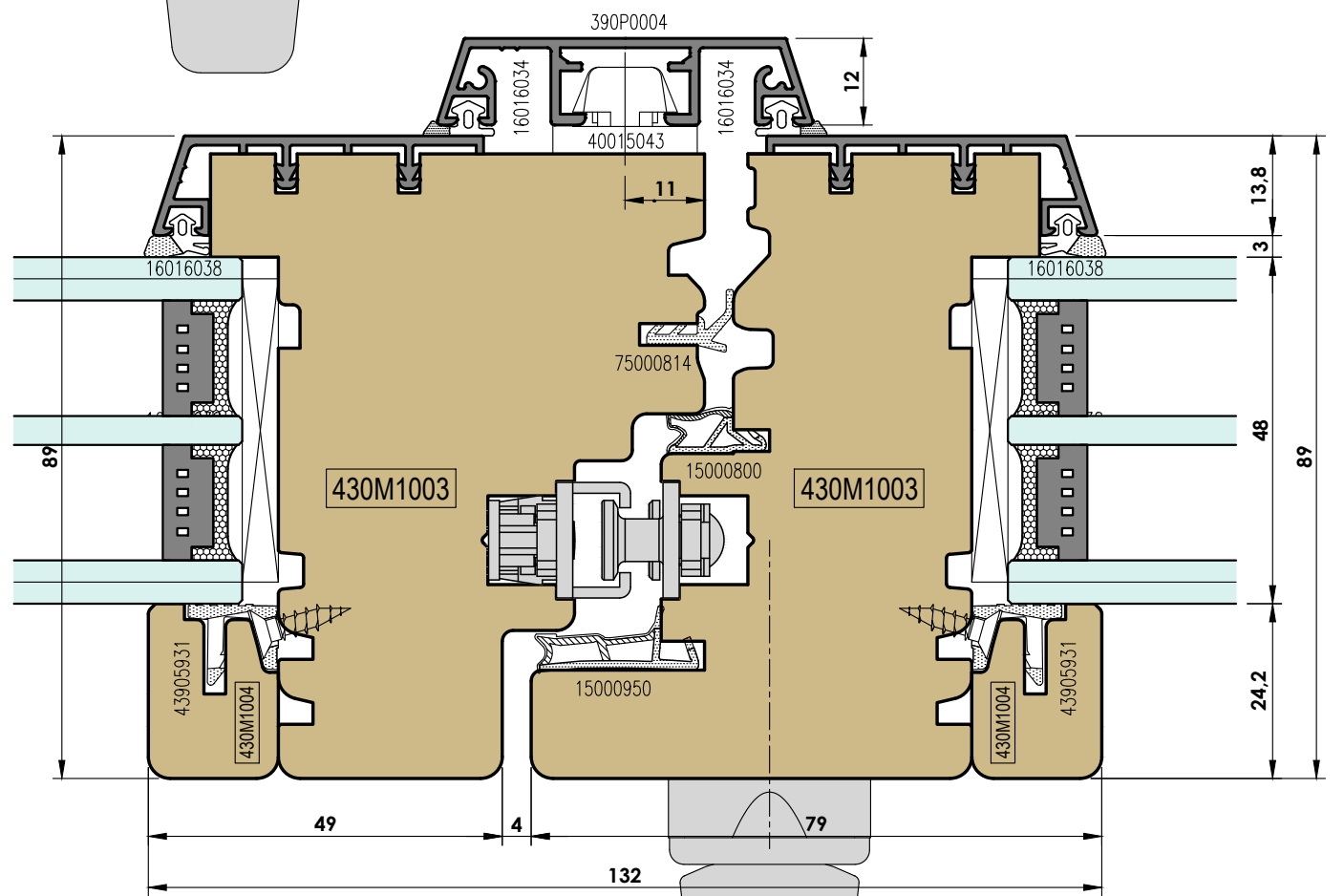
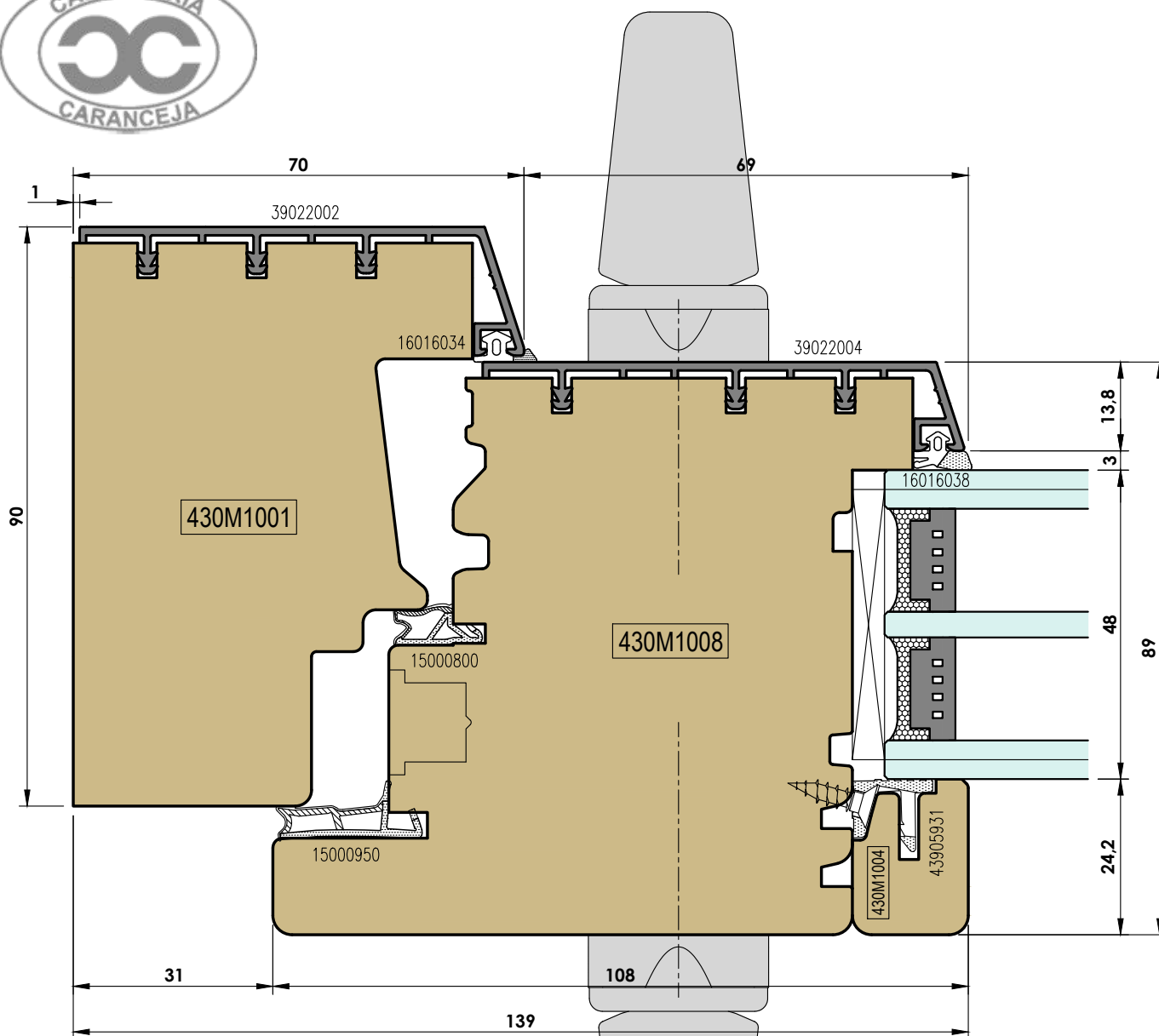

## HERMOD\_89

ESCALA 1:1

- (I) Sezione orizzontale snodo centrale
- (F) Section horizontale montant centrale
- (E) Seccion horizontal cierre central
- (UK) Horizontal section of the middle clamp

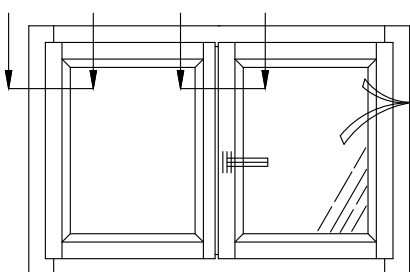
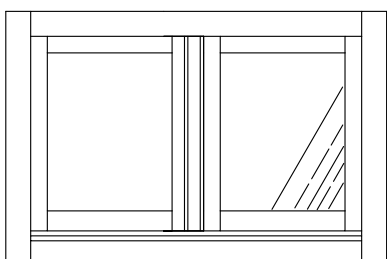
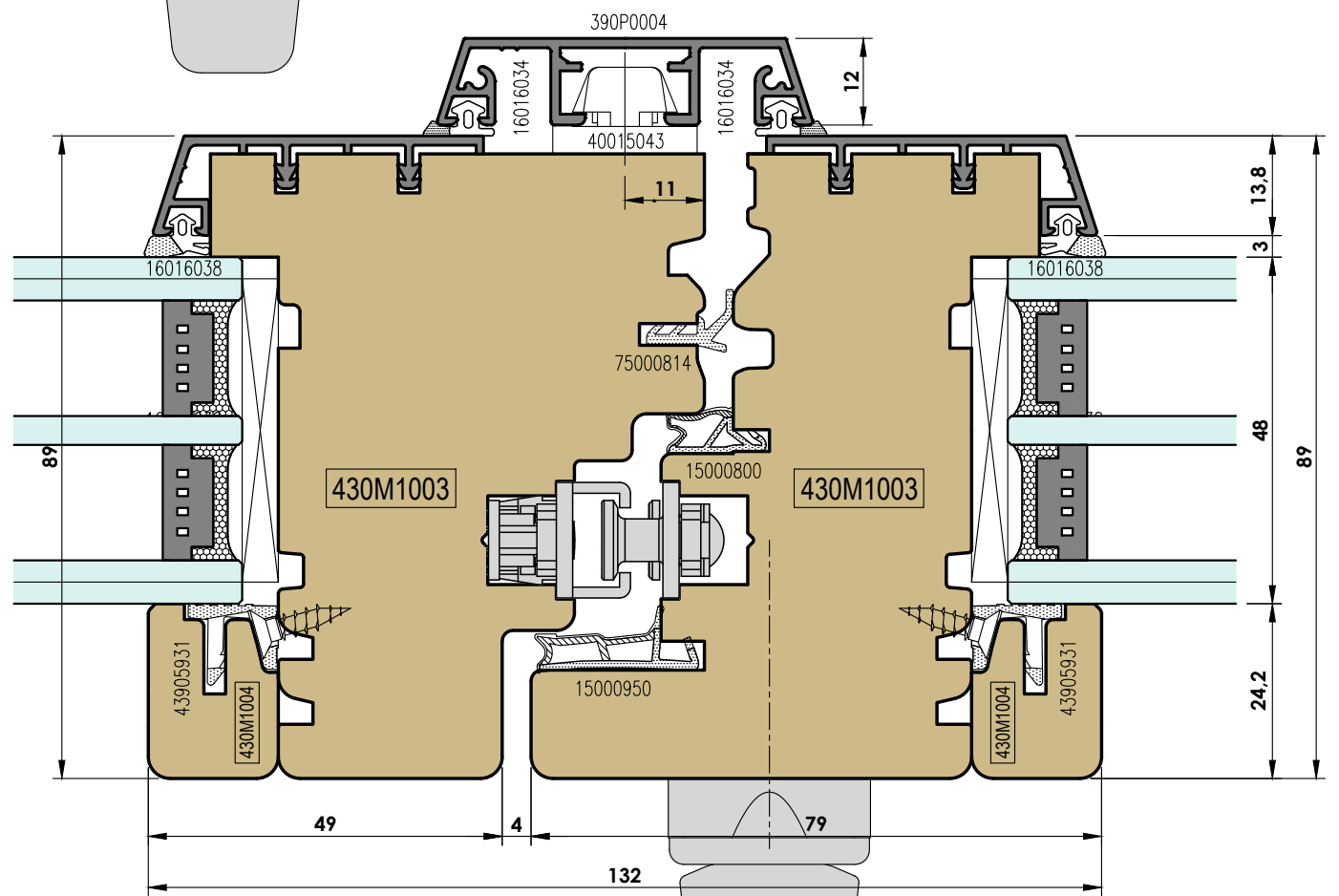
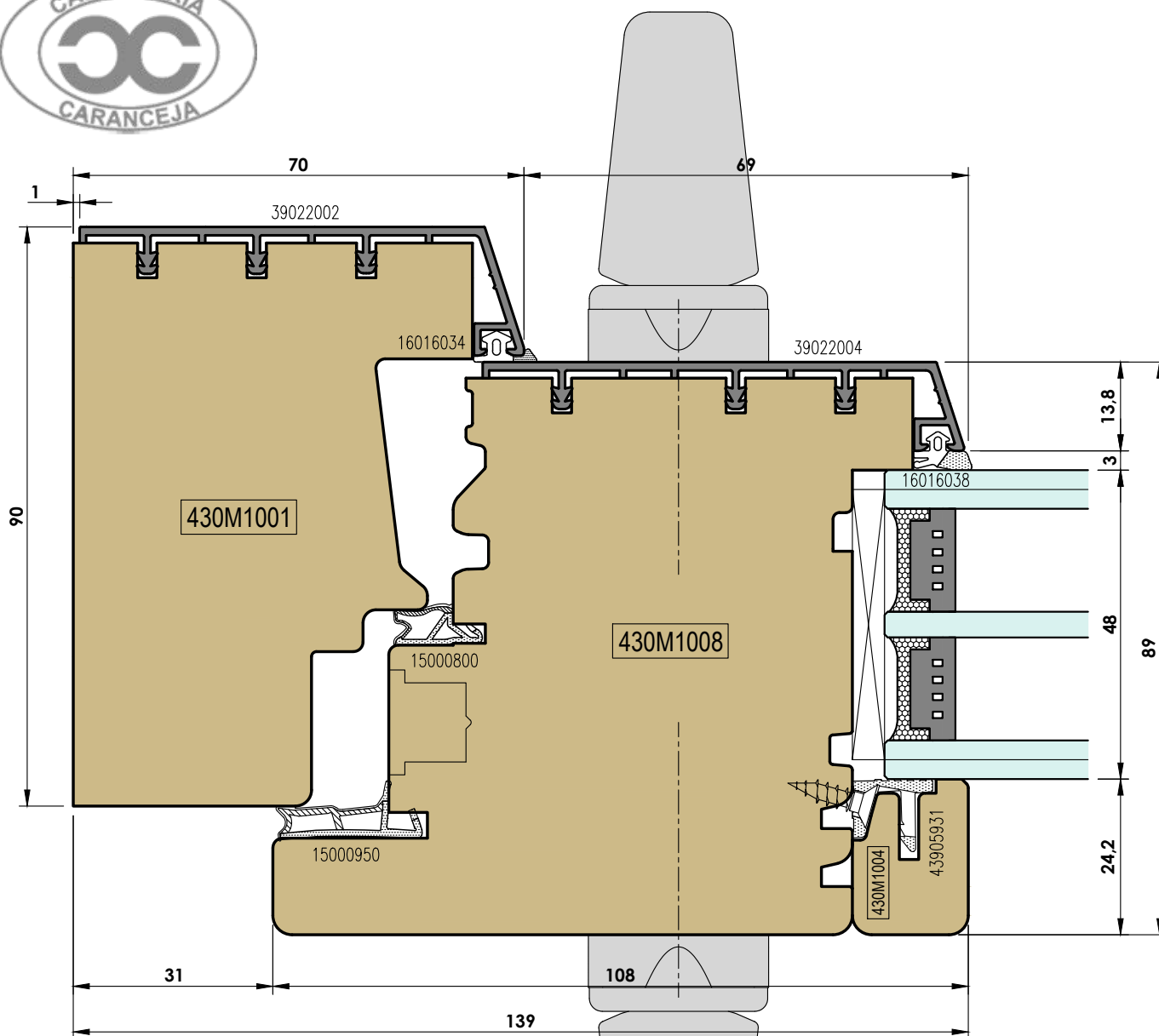

# HERMOD\_89

ESCALA 1:1

- (I) Sezione orizzontale snodo centrale
- (F) Section horizontale montant centrale
- (E) Seccion horizontal cierre central
- (UK) Horizontal section of the middle clamp

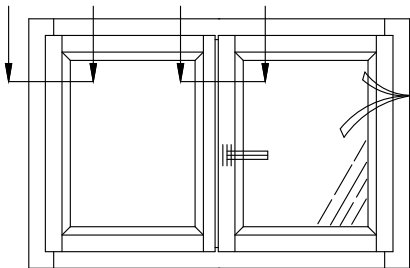
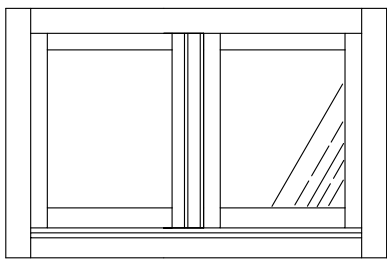
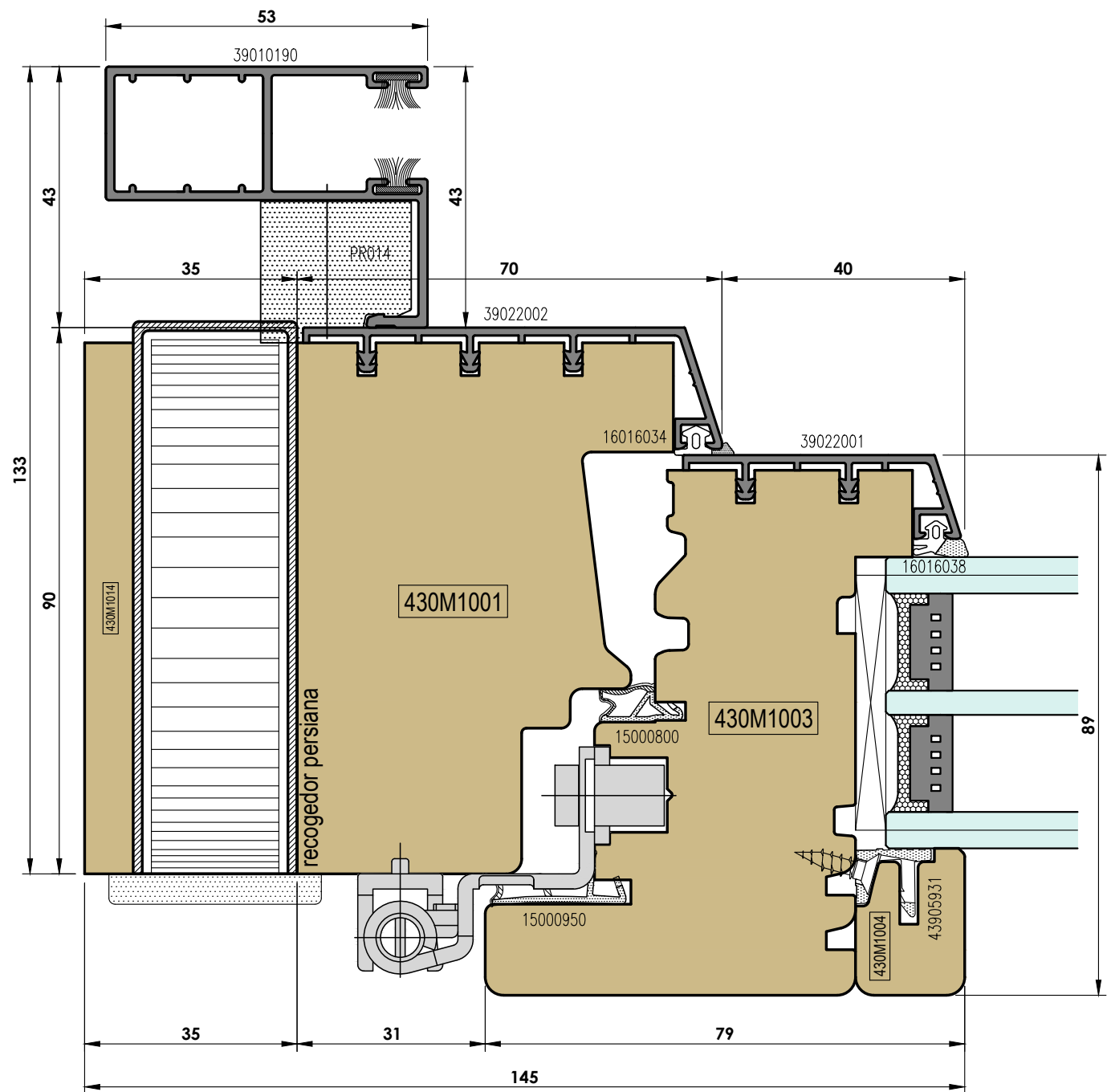

## HERMOD\_89

ESCALA 1:1

4

- (I) Sezione orizzontale snodo centrale
- (F) Section horizontale montant centrale
- (E) Seccion horizontal cierre central
- (UK) Horizontal section of the middle clamp

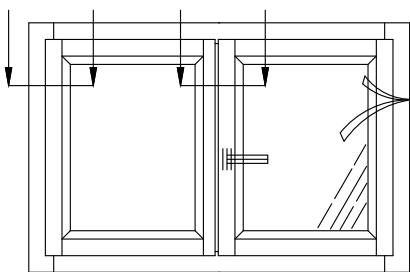
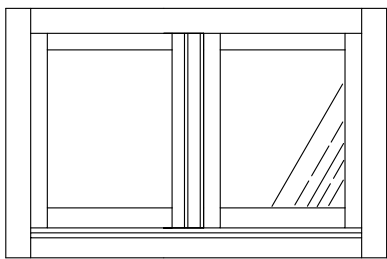
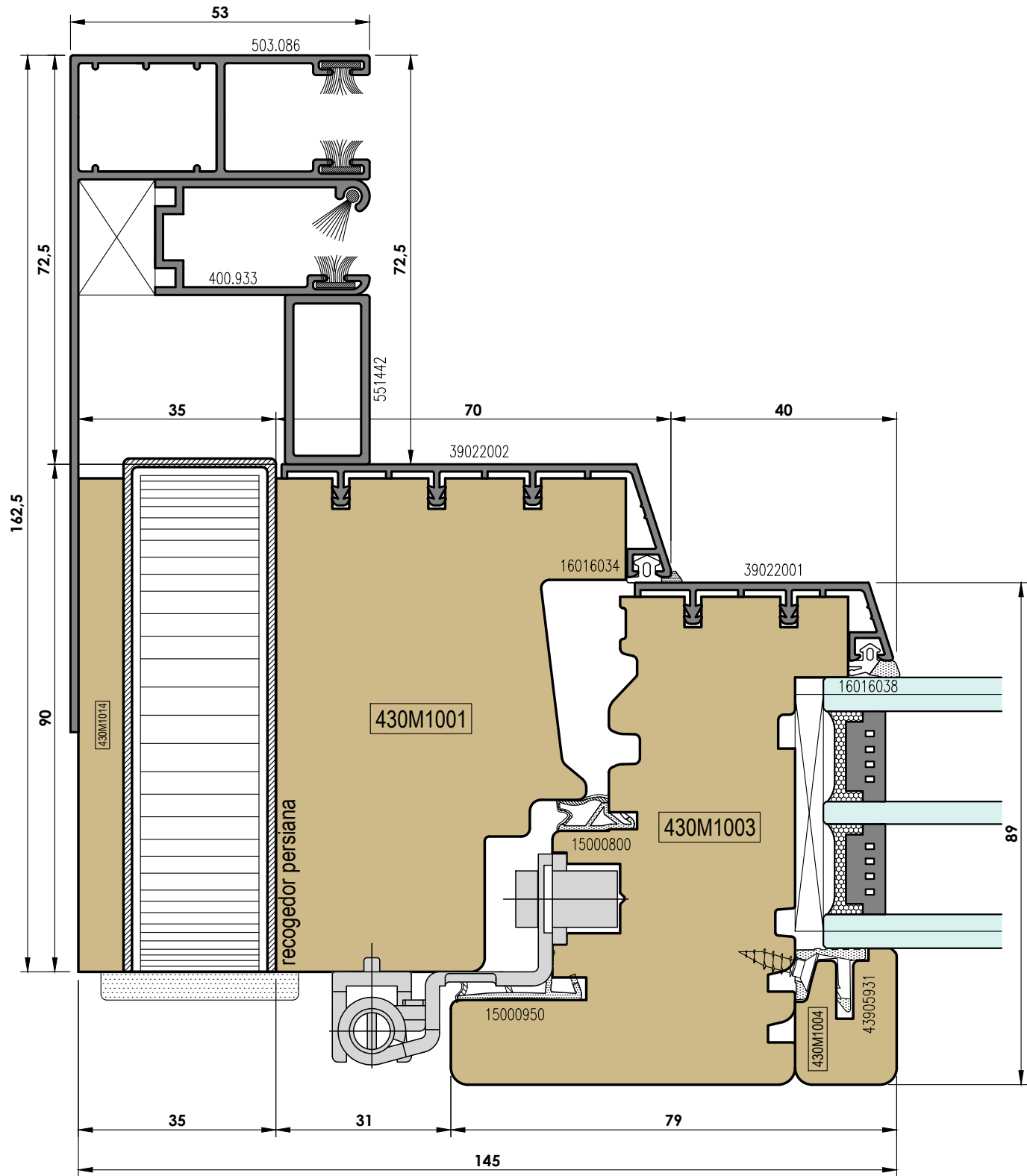

## HERMOD\_89

ESCALA 1:1

4

- (I) Sezione orizzontale snodo centrale
- (F) Section horizontale montant centrale
- (E) Seccion horizontal cierre central
- (UK) Horizontal section of the middle clamp

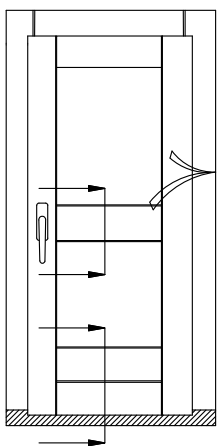
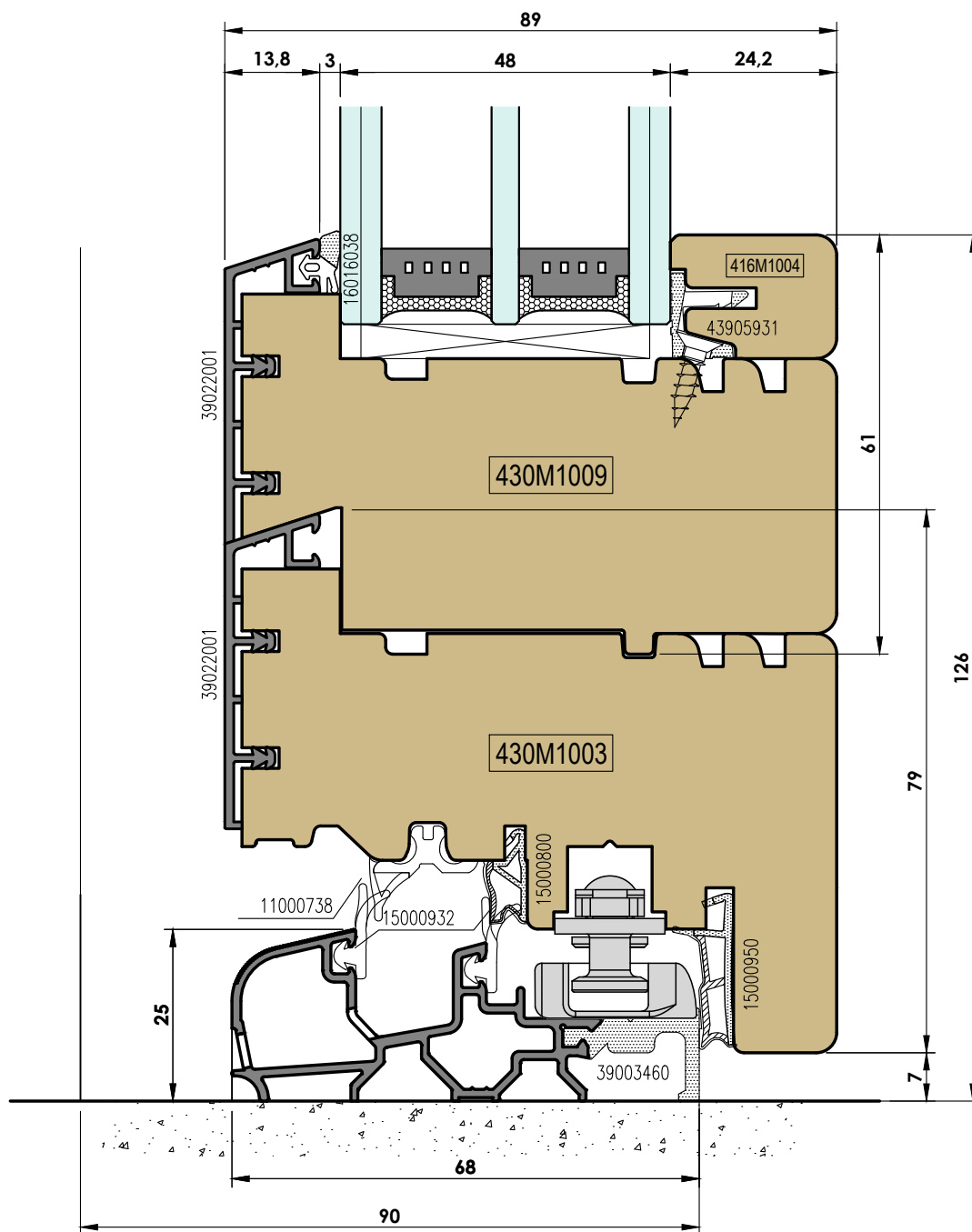
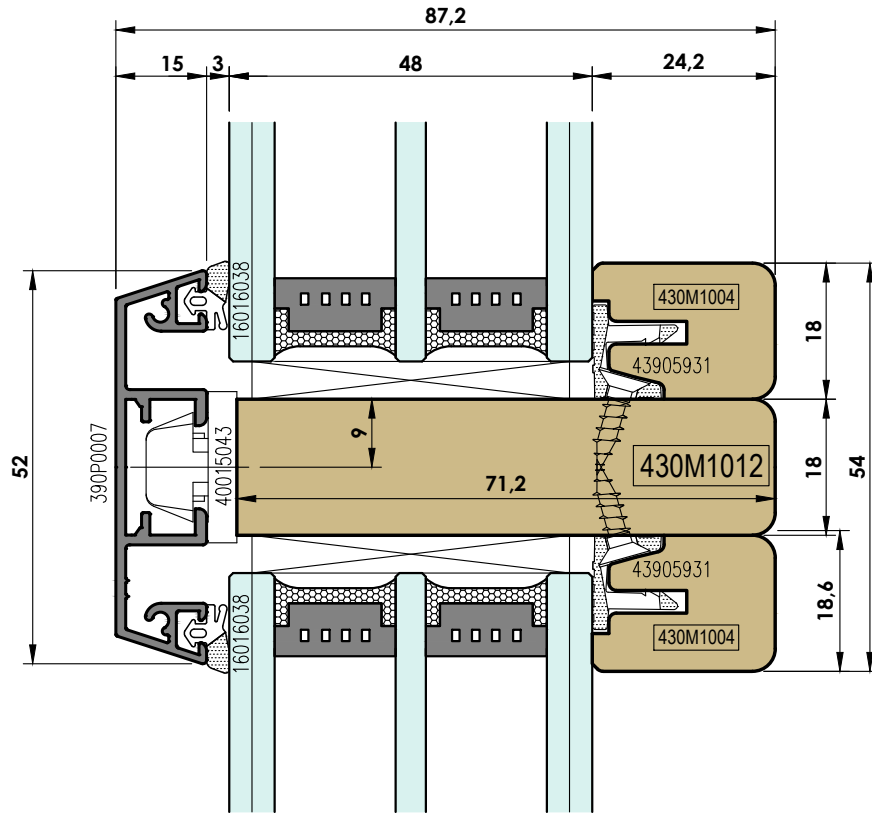

### HERMOD\_89

ESCALA 1:1

5

- (I) Sezione verticale traverso inferiore
- (F) Section verticale traverse inferieure
- (E) Seccion vertical travesañño inferior
- (UK) Vertical section lower ledger

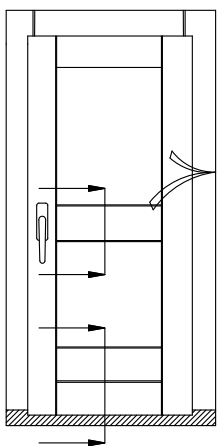
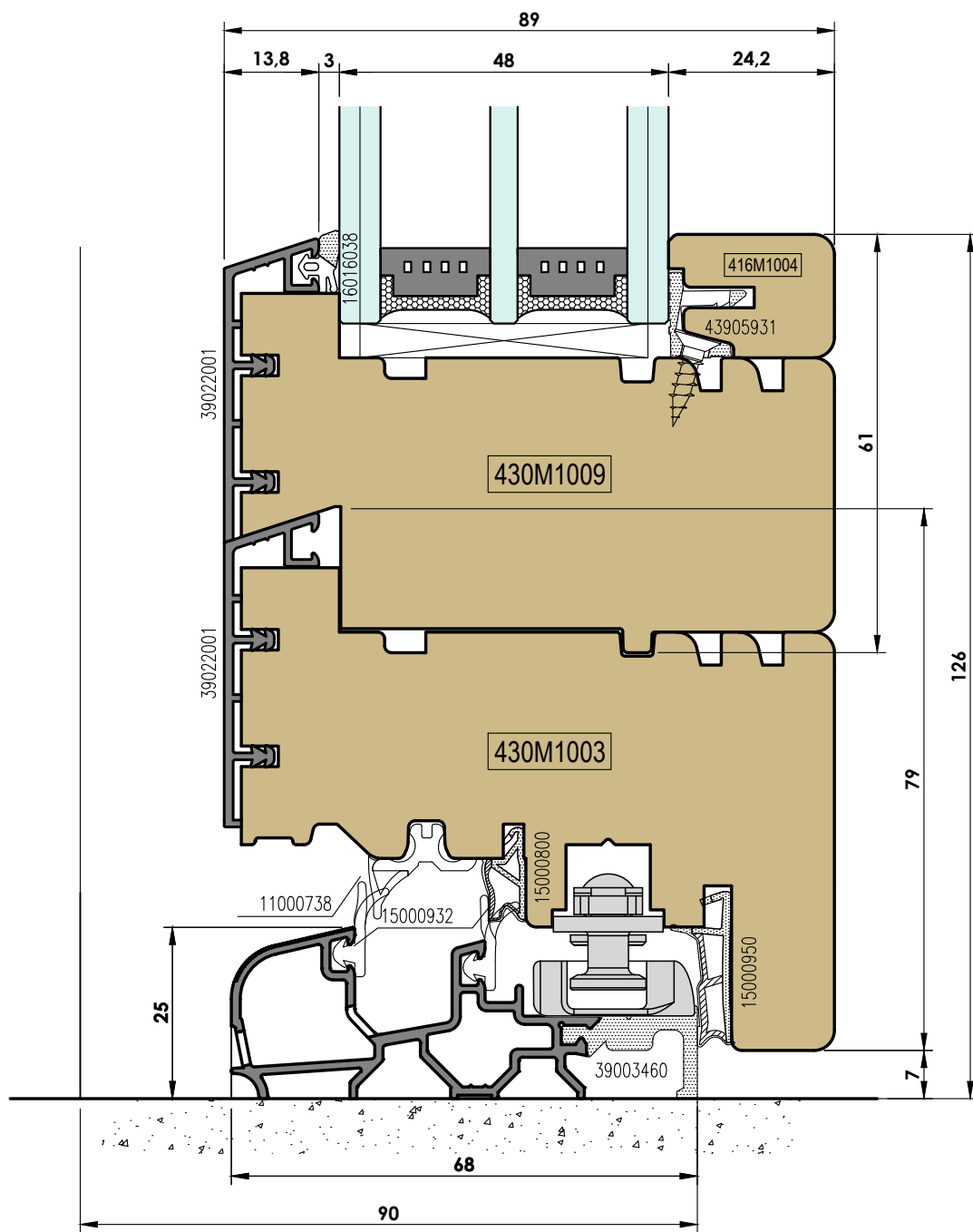
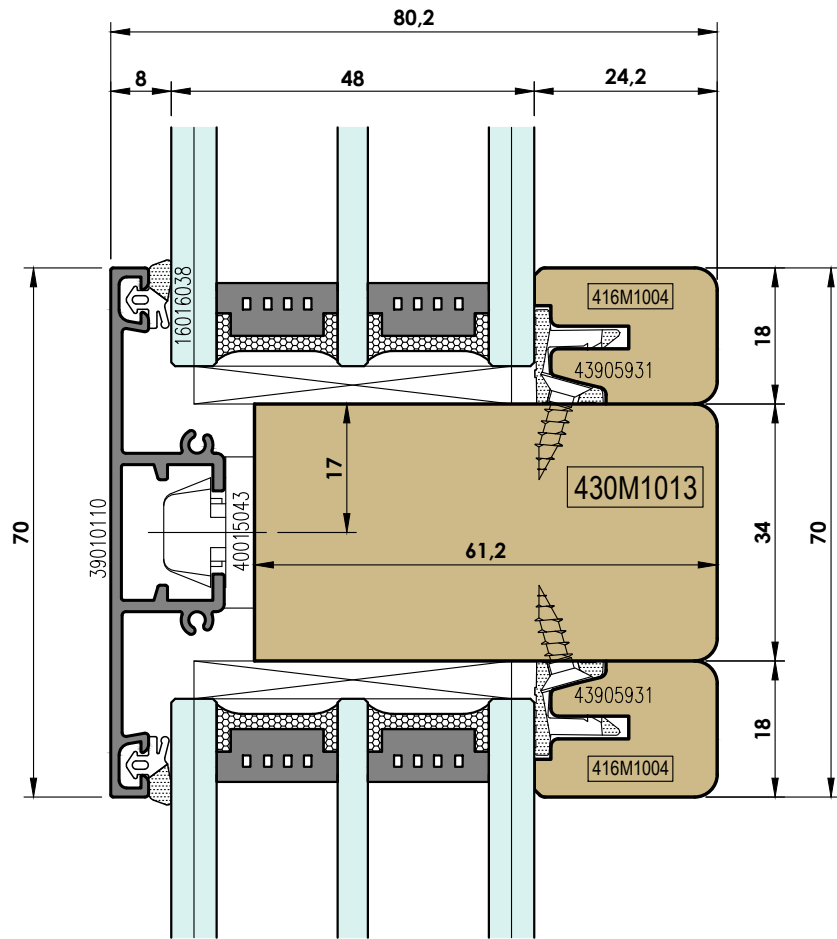

HERMOD\_89

ESCALA 1:1

5

- (I) Sezione verticale traverso inferiore
- (F) Section verticale traverse inferieure
- (E) Seccion vertical travesañõ inferior
- (UK) Vertical section lower ledger

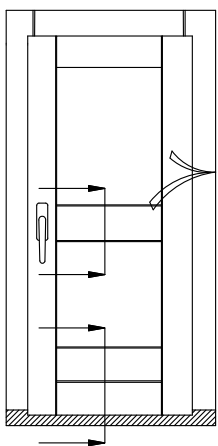
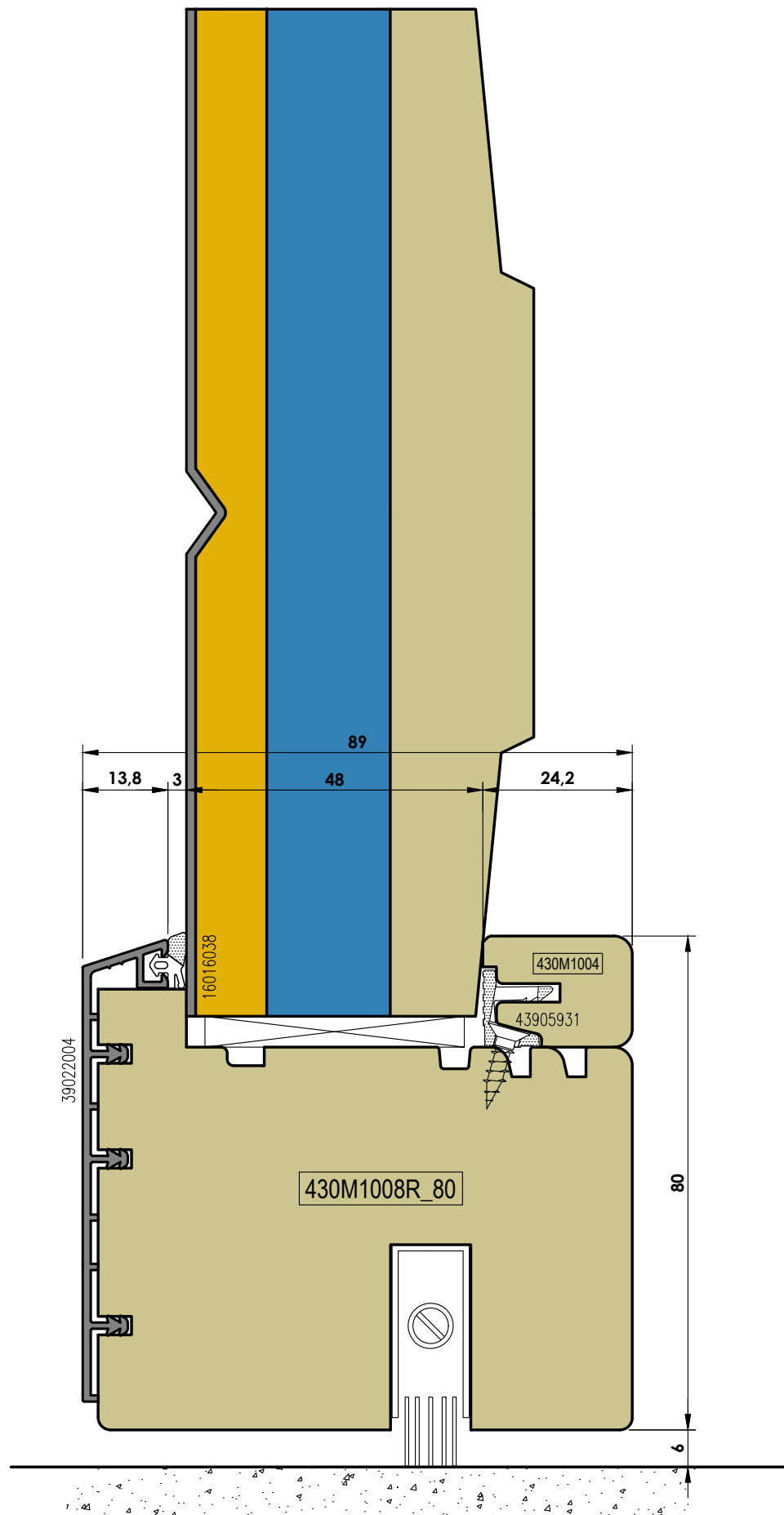

## HERMOD\_89

ESCALA 1:1

5

- Ⓚ Sezione verticale traverso inferiore
- Ⓛ Section verticale traverse inferieure
- Ⓧ Seccion vertical travesañõ inferior
- Ⓤ Vertical section lower ledger

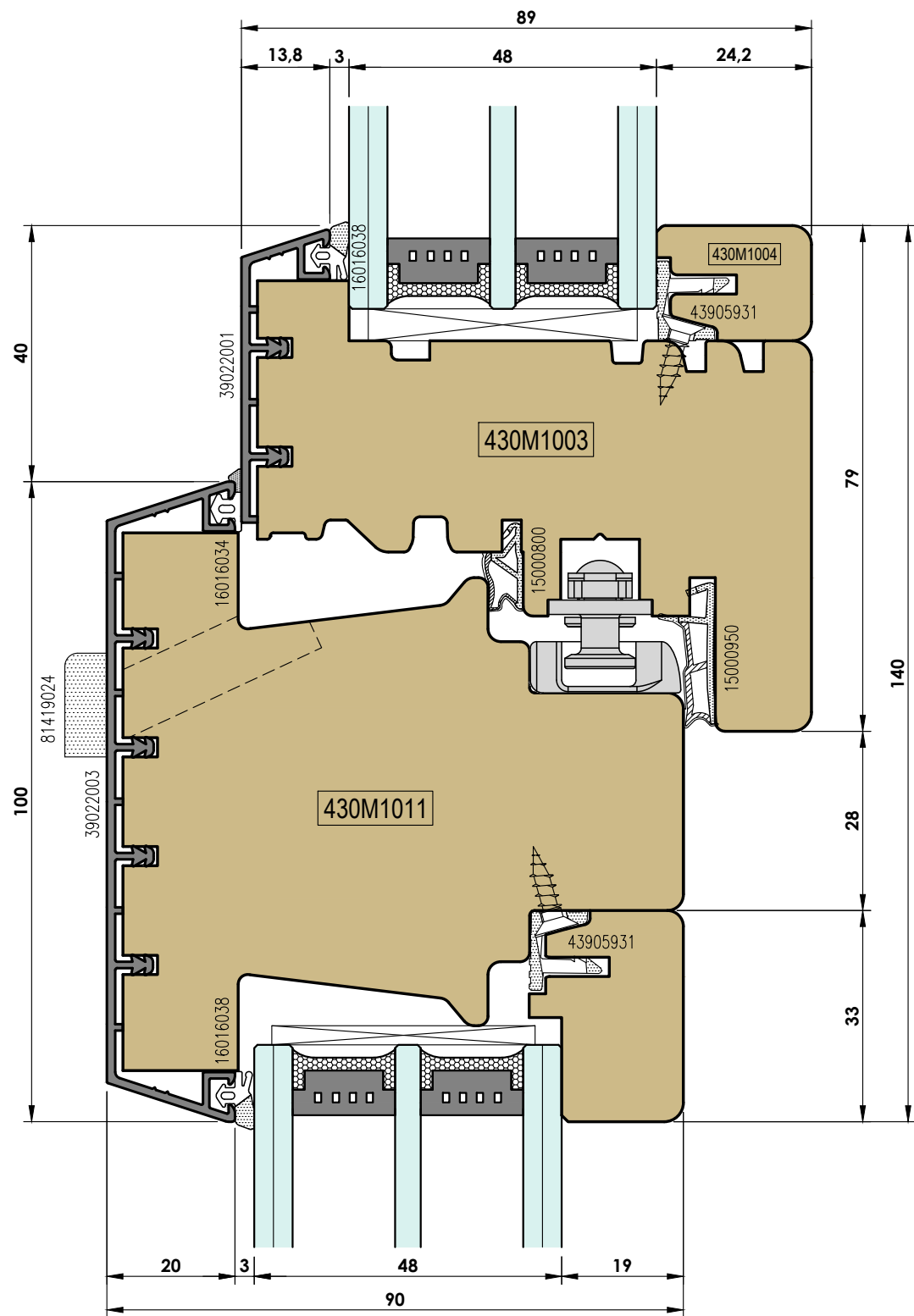
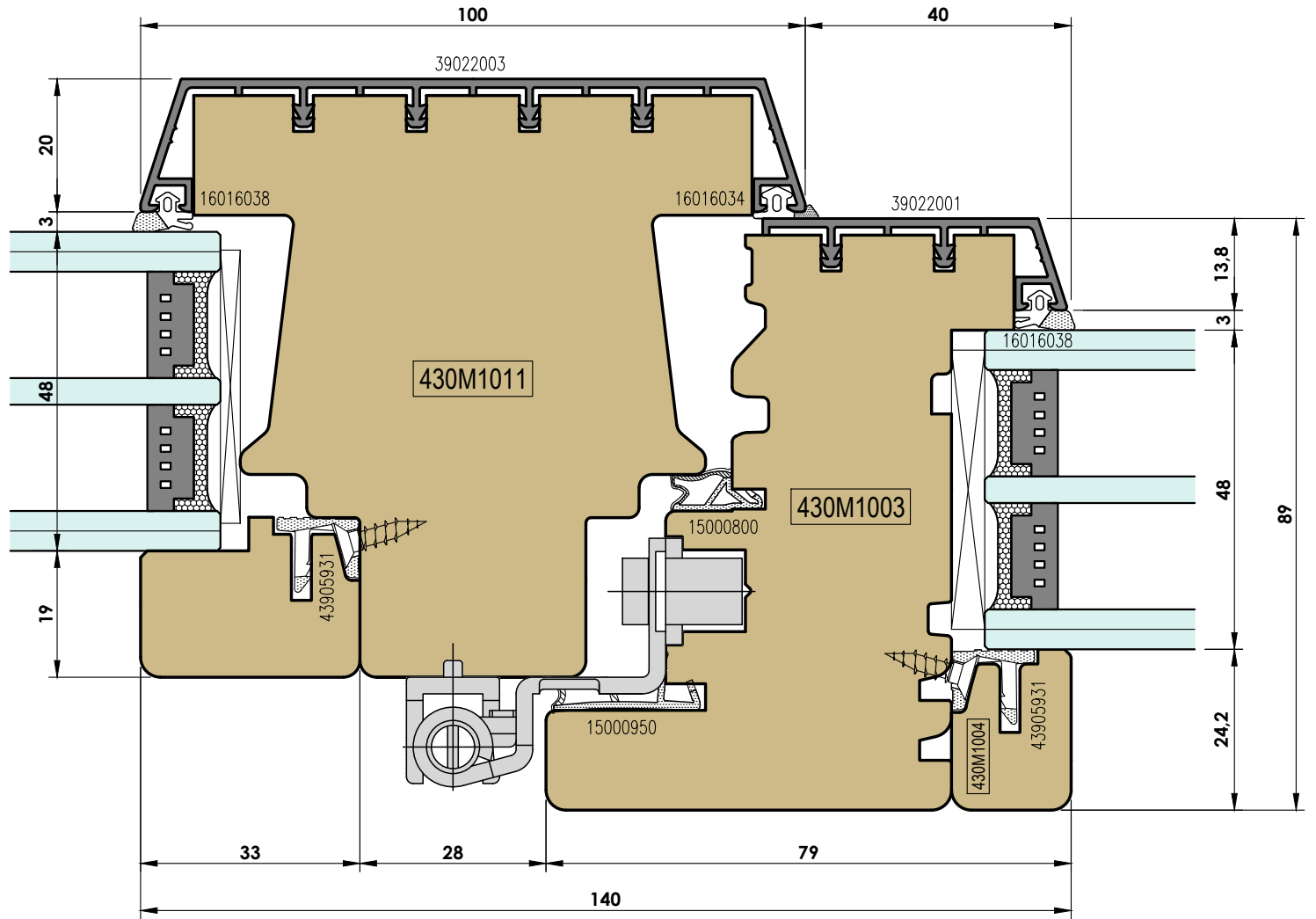

HERMOD\_89

ESCALA 1:1

1

- Ⓛ Sezione verticale traverso inferiore
- Ⓧ Section verticale traverse inferieure
- Ⓝ Seccion vertical travesañño inferior
- Vertical section lower ledger

